

How to make your own face mask

By Scottie Andrew, CNN

Illustrations: Leah Abucayan, CNN

Updated 4:53 AM ET, Sat April 4, 2020

(CNN) There's one thing you should know before diving into the [conversation around masks](#): The public should not purchase N95 respirators. Health care workers need those when they're [treating coronavirus patients](#).

You should also note:

- [Face covering](#) is *voluntary*
- Homemade masks are *not* a substitute for social distancing and staying home

Still, if you want to make a mask at home, here are step-by-step instructions -- based on guidance from the [Vanderbilt University Medical Center](#) and [Froedtert & Medical College of Wisconsin](#).

Not sure how to wear or clean the masks? We answer those questions under the mask-making instructions.

Materials you'll need

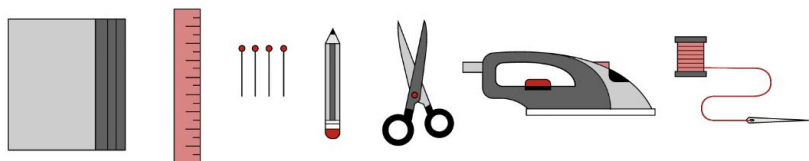

- 2 pieces of tight-weave cotton fabric, 9 x 6 inches (per mask)
- 4 strips of fabric, 2 x 16 inches (per mask)
- Ruler
- Sewing machine OR needle and thread
- Pencil or marker
- Scissors
- A handful of sewing pins
- Iron

Make your mask

1. Cut your fabric into two 9 x 6-inch rectangles. Place them on top of each other.

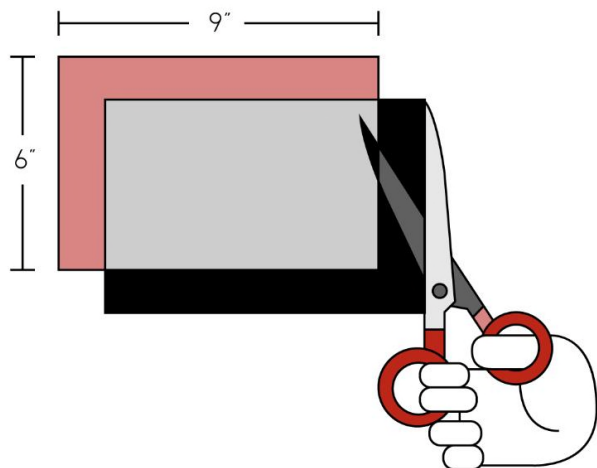

2. On the top of the 9-inch side, pin or mark a 2-inch opening in the center of the top edge of the 9-inch side, between the 3.5- and 5.5-inch points, along the top edge. Then, sew the edges on either side of where you pinned or marked the opening. You'll need that 2-inch opening to turn the mask right side out.

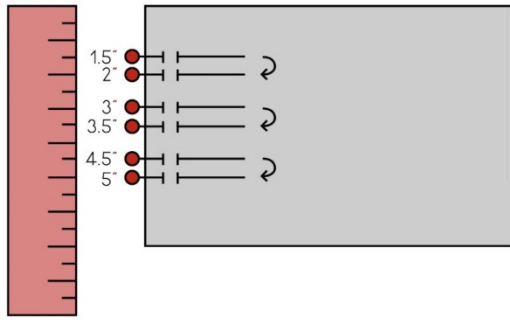

Pin again at the 2-, 3-, 3.5-, 4.5- and 5-inch lines.

6. Bring the pin at the 1.5-inch line down to the 2-inch line, and voila, you've made a pleat! Repeat with the 3-inch to the 3.5-inch and the 4.5-inch to the 5-inch line. Pin your new pleats, and repeat on the other side.

7. Sew the sides of your mask up so the pleats are laid flat.

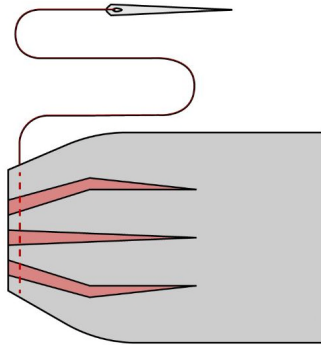

Make mask ties

1. Cut four strips of fabric, 2 inches wide by 16 inches long.

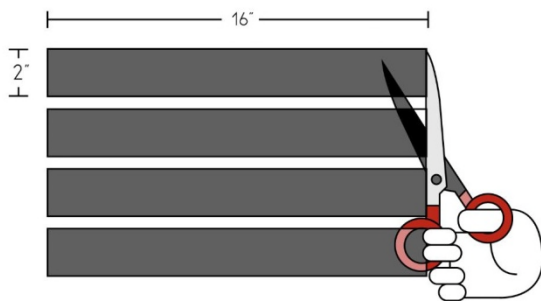

2. Fold them in half lengthwise.



3. Turn them under 1/4-inch on the long side.



4. Iron them in place, then stitch the long side shut.

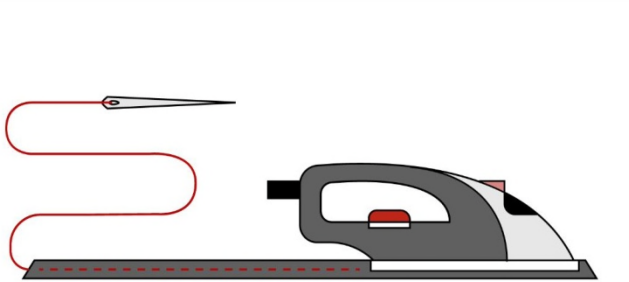

5. Pin each tie to a corner of the mask.

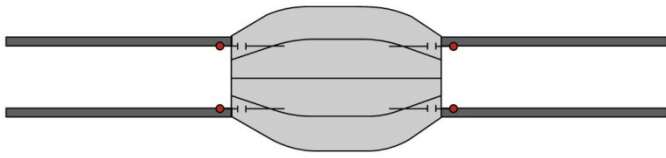

6. Sew around the perimeter of the mask once more so the ties are attached -- and now you've completed your mask.

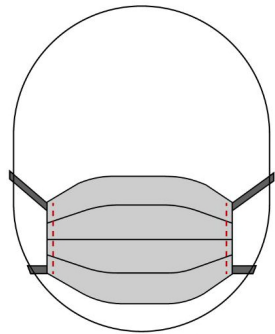
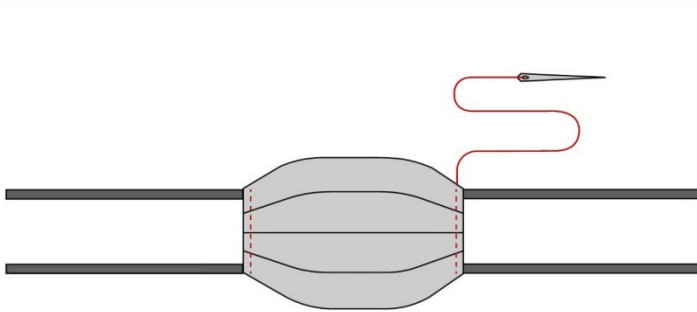

Mask FAQs

How do I wear it?

Masks are only effective if you wear them properly. The [World Health Organization](https://www.who.int) has the how-to:

- Wash your hands for 20 seconds with soap and water before touching or putting on the mask.
- Make sure your entire nose and mouth are covered when you put it on.
- Avoid touching the mask while you're out -- this can contaminate it.

- Do not take the mask off while you're in public.
- To take it off once you return, untie it from the back -- don't touch the front of it.
- You should immediately wash the mask after returning so it doesn't contaminate your belongings.
- Wash your hands immediately after you've taken it off, and again after you've washed the mask.

Are masks even effective?

Homemade mask [studies have shown that they're significantly less effective than surgical masks](#) -- and they're certainly no replacement for the essential N95 respirators health care workers must wear to treat patients.

"Homemade masks are partially effective," said Dr. Koushik Kasanagottu, an internal medicine resident at Johns Hopkins Bayview Medical Center in Maryland.

They offer a physical barrier from viral particles, he said, but they don't have the filters that N95 respirators do.

But they're better than nothing, especially for people who only go out in public to make a quick trip to the grocery store or pharmacy, said Anna Davies and Raina MacIntyre, public health researchers and authors of two separate studies on the effectiveness of cloth mask.

It's important to note, though, that masks cannot replace social distancing measures. Maintaining at least six feet of distance from others and staying home as much as possible is still the best way to prevent the spread of the virus.

How do you clean them?

You should launder the masks before and after each use to clean off any germs you might have picked up in public. Hand wash the masks or put them in a mesh wash bag in the washing machine so they don't fall apart, and use a high heat setting.

What if my craft store is closed or out of supplies?

[Crafters on Etsy](#) aren't sold out of face masks yet. It's difficult to discern how effective these masks are since you didn't craft them yourself, but you can compare them to our mask tutorial before you buy -- does it cover your nose and mouth? Are there pleats? Will it tightly seal around your face?

You likely don't need to buy more than a few masks -- physicians recommend that [only one member of each household runs errands in public](#).

It may take longer than usual to ship the masks, so be aware of this when you buy.

And be sure to wash the masks before you wear them.

If you can't access masks at all, then [keep washing your hands](#), maintaining distance from others and following other social distancing measures. Staying home is the best defense against coronavirus, after all.

Never used a sewing machine? Here's what you need to know
Sewing machines are intimidating if you've never used them, but they're not difficult to figure out. Watch this [comprehensive how-to video from sewing machine brand Singer](#) or read this [photo tutorial from NASA](#) -- yes, that NASA -- before you get started.